

Simulation Design of Dental Practice Medical Waste Management Using Dynamic System Model Approach

by Novita 3 Rany

Submission date: 15-Mar-2023 11:39AM (UTC+0700)

Submission ID: 2037559194

File name: 2353-Article_Text-11928-1-10-20221201.pdf (698.63K)

Word count: 5383

Character count: 29067



Simulation Design of Dental Practice Medical Waste Management Using Dynamic System Model Approach

Oktavia Dewi¹, Nila Puspita Sari², Raviola², Herniwanti¹, Novita Rani¹

¹ Magister of Public Health Departement, Universitas Hangtuah, Pekanbaru, Riau, Indonesia

² Bachelor of Public Health Departement, Universitas Hangtuah, Pekanbaru, Riau, Indonesia

Received: October 21, 2022
Revised: November 22, 2022
Accepted: November 28, 2022
Published: November 30, 2022

Corresponding Author:
Oktavia Dewi
dewitavia@yahoo.com

© 2022 The Authors. This open access article is distributed under a (CC-BY License)



DOI: [10.29303/jppipa.v8i5.2353](https://doi.org/10.29303/jppipa.v8i5.2353)

Abstract: Medical waste from dental practice is harmful to life and the environment. Previous studies reported that the total medical solid waste generated by dental practices in Pekanbaru City was 4.62 kg/day with an average of $0.3 \text{ kg} \pm 0.07 \text{ kg/day}$. Based on the type of waste generated, 69% is infectious waste, 27% is toxic waste, and 4% is radioactive waste. The purpose of the study was to analyze the medical waste generated and the environmental costs incurred by dentists using several scenarios of medical waste management policy intervention. The method used is a simulation model with a dynamic system approach. Simulations were carried out from 2018 to 2047. The results of the study obtained a percentage reduction for 30 years, it was found that the combination of providing training and cooperation with the waste management party had the largest decrease of 41.9%. The biggest decrease in environmental costs was the combined scenario of 99.69%, followed by the 99.62% cooperation scenario and 19.5% training. The most effective self-care solid medical waste management model is the scenario 3 model because it can reduce the waste generated and also reduce costs.

Keywords: Simulation design; Medical waste; Dynamic system model approach; Waste management

Introduction

The medical waste management system in Indonesia is regulated based on Minister of Health Regulation No. 7 of 2019 (Peraturan Menteri Kesehatan RI, 2019) regarding rules and procedures for managing medical waste in hospitals. The Minister of Health Regulation still regulates the procedures for managing waste in a hospital environment and its surroundings, while for medical waste in other health service facilities, especially dental practice waste, there is no statutory policy that regulates it. A study by Singh et al., (2014); Benakatti & Kanathila, (2018) reported that there are no standard rules regarding the management of dental health medical waste either from the government or from dental professional organizations.

The results of a study by (Dewi et al., 2019) reported that the total amount of solid medical waste produced by dental practices in Pekanbaru City was 4,62 kg/day with the average medical waste produced by each

dentist being $0,3 \text{ kg} \pm 0,07 \text{ kg/day}$. Meanwhile, based on the type of waste produced, 69% was an infectious waste, 27% was toxic waste, and 4% was a radioactive waste.

Dental practice medical waste can endanger the lives of living things and the environment around them, such as health problems, and social and economic disturbances in society due to pollution (Eleyan et al., 2013; Adipraja et al., 2018). Following the development of the healthcare industry, it can be predicted that more medical waste will be produced (Manchanda et al., 2015). Therefore, it is necessary to have alternative medical waste management for dental health services. It is necessary to design a strategy that can predict the amount of waste and costs needed to manage medical waste in dental practice. Human resources are the main factor so an effort to gain more knowledge is required through training to be able to manage medical waste properly (Retnowati et al., 2021). The analysis used is by creating a simulation model to predict the amount of

How to Cite:

Dewi, O., Sari, N.P., Raviola, R., Herniwanti, H., & Rany, N. (2022). Simulation Design of Dental Practice Medical Waste Management Using Dynamic System Model Approach. *Jurnal Penelitian Pendidikan IPA*, 8(5), 2483–2492. <https://doi.org/10.29303/jppipa.v8i5.2353>

waste generated based on the calculation of variables in waste management, which is an increase in the number of dentists, the amount of solid medical waste based on its type (infectious, toxic and heavy metal), and able to plan the frequency and time of retraining with a dynamic systems approach. The dynamic system approach is used to produce a medical waste management model for independent dental health services in Pekanbaru city. The analysis used is to create a simulation model to get an alternative description or phenomenon that is designed to determine alternative policies to be applied in medical waste management in dental practices (Artika & Chaerul, 2020; Wildanurizzal et al., 2014).

Method

This is quantitative research conducting a preliminary study to obtain information about the amount of waste, and the behavior of dentists in Pekanbaru City in managing medical waste. Then proceed with a literature study by looking for supporting theories related to medical waste

management and regulations on medical waste management.

The dynamic system modeling uses Powersim Studio 8 Software. Data collection methods are conducted by literature study and survey methods. The dynamic model of medical waste management for dental health services is conducted using a systems analysis approach. The types of data required in the dynamic model consist of; primary data and secondary data (Al-Khatib et al., 2016; Chaerul et al., 2008). Primary data in this study are data collected through direct observation and interviews with dentists. Secondary data are data obtained from the literature. There are several stages in making a dynamic system model, they are; Creating the drafting concept of macro and micro models; Creating Causal Loop Diagram (CLD); Creating Stock Flow Diagrams (SFD); Run Software; Validation; Existing Simulation, and Creating Scenarios.

Before modeling, it is necessary to determine the operational definition and measurement results of each variable that will be included in the modeling as shown in Table 1.

Table 1. Operational definition of variables that will be made as independent dental health service modeling in Pekanbaru City

Variables	Operational definition	How to measure	Measurement results
Solid medical waste	Total solid medical waste of dental health services produced daily	Weigh it daily for 20 days	The total is 49.170 grams Average 330 grams/dentist/day (Dewi et al., 2019)
Infectious solid waste	Dental health care waste contaminated with patient's blood and saliva can transmit disease	Weigh it daily for 20 days	The total is 63.758 grams Average 227,7 grams/dentist/day (Dewi et al., 2019)
Toxic waste	Dental health care waste containing toxic chemicals	Weigh it daily for 20 days	The total is 24.949 grams Average 89,10 grams/dentist/day (Dewi et al., 2019)
Heavy metal waste	Dental health care waste containing heavy metals	Weigh it daily for 20 days	The total is 3.595 grams Average 13,20 grams/dentistday (Dewi et al., 2019)
Dentist	The number of dentists who provide independent health services in Pekanbaru City	PDGI secondary data of Pekanbaru city branch in 2018	149 people
The increase in the amount of dentist	Percentage of increase in the amount of dentist year in Indonesia 7,1%	Indonesia Health Profile Data 2016 and 2017	2016 = 13.425 2017 = 14.455
Knowledge	Dentist's knowledge of the definition, causes, effects, and, ways of managing waste	Survey results	Dentist's good knowledge level of 75% (Notoatmodjo, 2014)
Behavior	The action of the dentist /dental nurse in managing waste by sorting, storing, and, destroying it	Survey results and observations	Proper behavior in managing waste accordingly of 42.3% (Dewi et al., 2019)
Air pollution	Potential air disturbances that occur due to amalgam (mercury)	The results of measuring the number of pollutants and the Minister of Environment and Forestry Regulation No. 7 of 2016 concerning environmental losses due to	The quality standard of mercury in the air is 0,05 mg/m ³ . The quality standard for mercury in water is 0,002 mg/liter. If the mercury produced is more or equal to 4 grams/unit it will cause pollution.
Water pollution	Potential water disturbances that occur due to amalgam (mercury)		

Variables	Operational definition	How to measure	Measurement results
Environmental Costs	Costs that must be incurred by a waste generator due to suspected environmental damage based on Minister of Environment Regulation No. 7 of 2014 concerning Environmental Losses Due to Pollution and/or Environmental Damage	pollution and/or environmental damage (Peraturan Menteri Lingkungan Hidup dan Kehutanan RI, 2016) Results of medical waste measurement and literature study	Costs of environmental damage due to mercury pollution: a. Air/Gas Emission for each unit of 4 grams is Rp. 24.750. b. The parameter wastewater for each unit of 20 grams is Rp. 24.750.
Training		Interviews and literature study	1 waste management training costs Rp. 5.500.000 per person for 2 days
Cooperation with private waste management		Interviews	1 kg of medical waste costs Rp 40.000

Result and Discussion

The operational stages of designing a dynamic model of medical waste management for dental health services in Pekanbaru City are as follows:

Developing a conceptual model that includes macro conceptions and micro conceptions.

Macro conception is the general conception of the model being built, while micro conception is the more detailed conception of the reciprocal relationship between the existing structures in the model (Brady et al., 2020); (B. Lewis et al., 2020). The macro conception of the independent health service medical waste management model is based on the relationship between dentists as medical waste producers, the environment, pollution, and policies. The increase in the amounts of dentists, which is increasing every year, will affect the

medical waste they produce it disrupts environmental sustainability with the potential for pollution so a waste management policy is needed to control the amount of medical waste produced (Wulandari & Kusnopranto, 2015; Shareefdeen, 2012).

The micro conception the of independent health service medical waste management model in Pekanbaru City refers to a more detailed macro conception of the relationship between the existing structures. The increasing amounts of dentists each year increase the amount of medical waste, requiring adequate knowledge to form appropriate waste management behavior so the potential impact of environmental disturbances such as pollution can be reduced. If pollution can be reduced, the cost of environmental damage can be diverted to provide training and cooperation with private waste managers. The macro and micro concepts are shown in Figure 1.

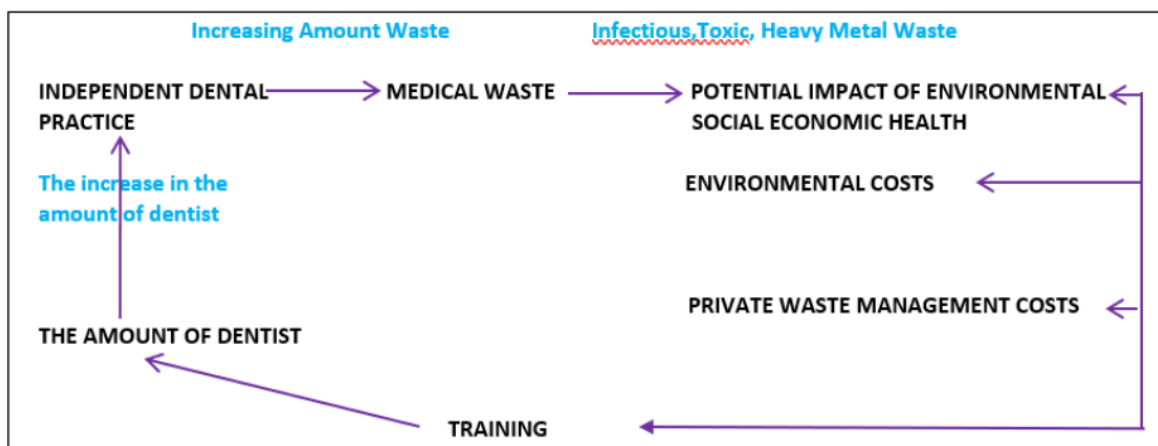

Figure 1. Macro and micro concepts of dental practice medical waste management simulation.

Results of Causal Loop Diagram (CLD)

Based on variables that will be included in the modeling, a Causal Loop Diagram (CLD) is created to explain the description of the reciprocal relationship or causal relationship of the existing variables. The CLD diagram can be seen in Figure 2.

In Figure 2, it can be seen that an increase in the amounts of dentists will affect the increase in the amount of medical waste produced. In terms of the increase in the amount of medical waste, dentists are affected by their waste management behavior. If the dentist has good waste management behavior, the waste produced

will not cause a problem. On the other hand, if a lot of dentists have bad waste management behavior and do not comply with the rules, the medical waste produced will have the potential to disturb the environment, causing pollution. Because of this pollution, according to the legislation, the waste producer must pay environmental costs as compensation for environmental damage. To reduce the amount of medical waste that causes pollution and environmental costs, waste management training and cooperation with private waste management need to be done.

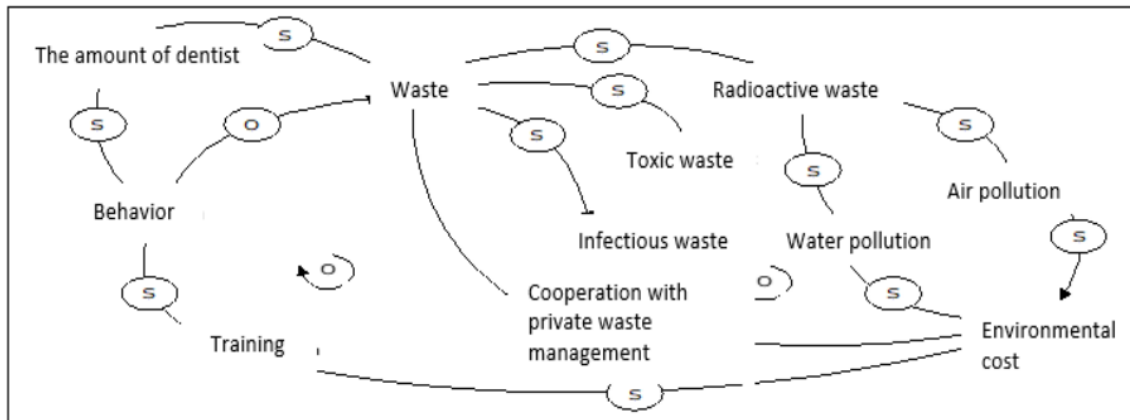

Figure 2. Causal loop diagram of a medical waste management model for public dental health services.

Results of Stock Flow Diagram (SFD)

A stock-flow diagram is a depiction of the reciprocal relationship of existing structures in the form of stock (level), flow, auxiliary, constant, and information link. To make SFD, several simulations are conducted to predict the amount of waste and environmental costs.

Dynamic simulation is conducted using a systems analysis approach (modeling). System analysis is to see changes dynamically (temporal) within a certain period. Changes in the amount of medical waste along with the increase in the amounts of dentists and their impact on the environment (pollution) become the main model in system analysis.

The model simulation began in 2018 as an existing condition (baseline) and was simulated over a period of 30 years. The year 2047 is used as the deadline for the simulation. Simulations were performed 4 times with 3

scenarios. The first simulation is conducted when there was no intervention on the amount of waste and environmental costs, the second simulation is conducted with scenario 1 by intervening if medical waste management training for dental health personnel is done once; The third simulation is cooperation with waste management party scenario to transport medical waste periodically and the fourth simulation is combination intervention scenario between conducting training and cooperation with waste management. The results comparison of the four simulations can be explained as follows:

- a. Simulation I is a simulation of the amount of existing waste condition to estimate the production of solid medical waste for dental health services from independent dental health services in Pekanbaru City for 30 years (2018-2047) with a dynamic model approach without intervention scenarios (Figure 3).

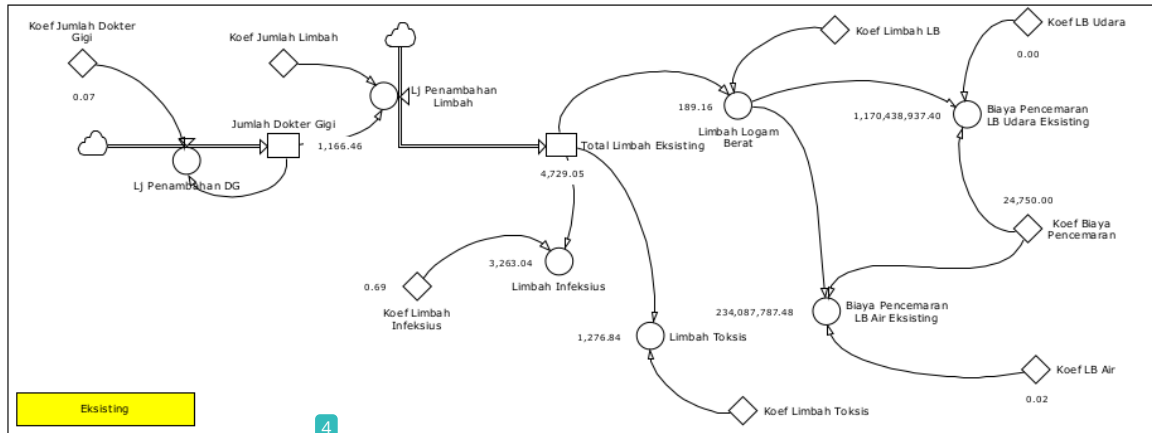

Figure 3. Flow diagram of a medical waste management model for dental health services in Pekanbaru City without intervention (existing)

b. Simulation II is a dynamic model simulation of medical waste management for dental health services in Pekanbaru city to predict the production

of medical waste and environmental costs for 30 years (2018-2048) if scenario 1 interventions are conducted, which is providing medical waste management training once (Figure 4).

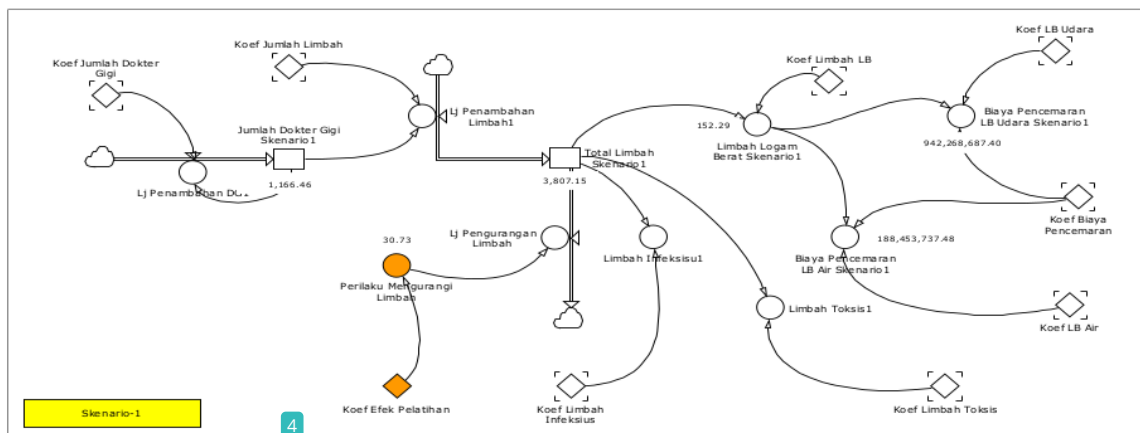

Figure 4. Flow diagram of a medical waste management model for dental health services in Pekanbaru City with providing training scenario intervention.

Figure 4 shows the amount of waste in scenario 1 is affected by an increase in dentist waste management behavior by 30.73% due to intervention by providing training so the amount of waste in the 30th year (2048) becomes 3.807.15 kg. By improving waste management behavior, the waste management costs will also be reduced to obtain the environmental cost of Rp. 1.130.722.424 (water pollution Rp. 188.453.737 + air pollution (Rp.942.268.687).

c. Simulation III is a dynamic model simulation of solid medical waste management for dental health services in Pekanbaru city to predict the production of medical waste and environmental costs for 30 years (2018-2048) if scenario 2 intervention is conducted, which is cooperation with private waste management (Figure 5).

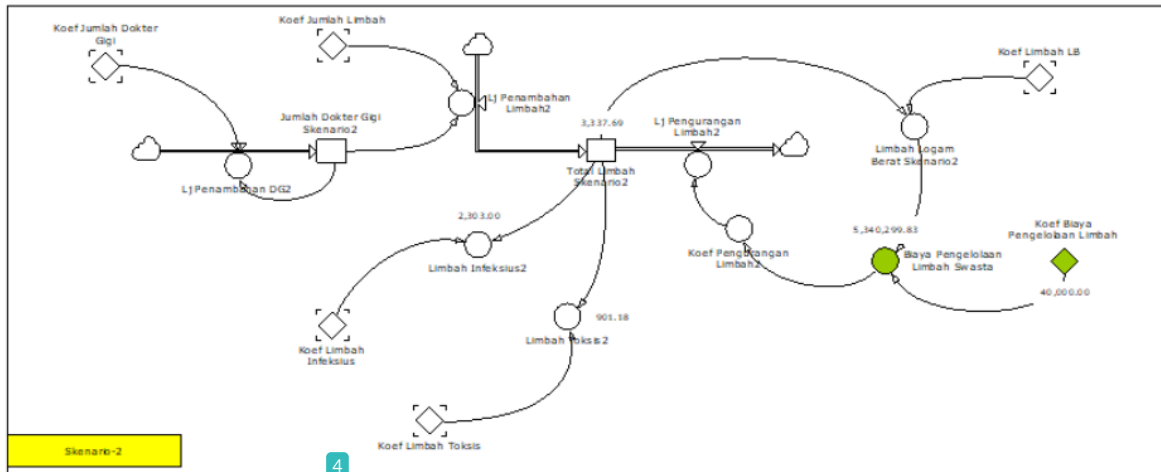

Figure 5. Flow Diagram of A Medical Waste Management Model for Dental Health Services In Pekanbaru City with Cooperation With Private Waste Management Scenario Intervention.

Figure 5 shows the amount of waste and waste management costs in scenario 2 if cooperation with private waste management is conducted to manage heavy metal waste so the cost of pollution due to heavy metals can be reduced. The fee paid to a private medical waste management company is Rp. 40.000 per kilogram.

With this cooperation, the predicted amount of waste is 3.337.69 kg. By improving waste management behavior, the waste management costs will also be reduced so the environmental cost that must be paid is Rp. 5.340.299. This is because all heavy metal waste has been managed by private medical waste management companies.

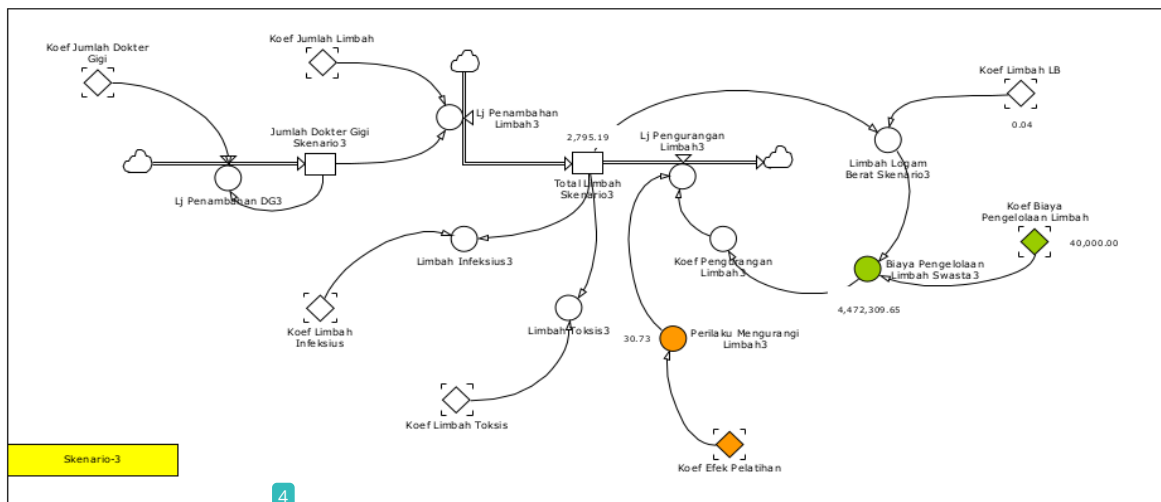

Figure 6. Flow diagram of a medical waste management model for dental health services in Pekanbaru City with training and cooperation with private waste management scenario intervention.

d. Simulation IV is a dynamic model simulation of medical waste management for dental health services in Pekanbaru City to predict the production of medical

waste and environmental costs for 30 years (2018-2048) if scenario 3 intervention is conducted, which is waste management training once and cooperation with private waste management.

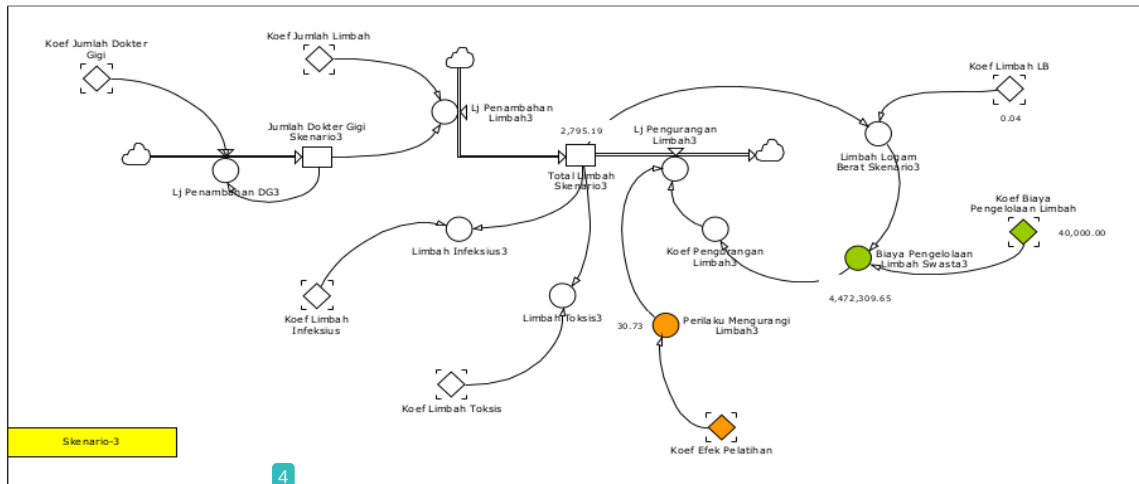

Figure 6. Flow diagram of a medical waste management model for dental health services in Pekanbaru City with training and cooperation with private waste management scenario intervention.

Figure 6 shows that the amount of waste is 2,795,19 kg and the cost of waste management is Rp. 4.472.303. Scenario 3 is affected by an increase in dentist waste management behavior according to the rules of 30,73% and cooperation with private waste management companies with a fee of Rp. 40.000 per kilogram.

Based on simulation comparison results of the amount of medical waste produced and costs that must be conducted in Pekanbaru City, the 7 are 3 waste management intervention scenarios to reduce the amount of medical waste and environmental costs produced. The trend comparison results of the amount of solid medical waste can be shown in Figure 7.

Figure 7 shows that the scenario that is most effective in reducing the amount of waste each year is the combination of providing training and cooperation with the licensed waste management company. This shows that by providing training in medical waste management to dentists and dental nurses as waste producers they will be able to increase their knowledge and be able to change behavior in waste disposal. This result is from a study by Gihan which stated that 80% had bad behavior before being given medical waste management training, reducing to 0.8% after training. On the other hand, 1.1% had good waste management behavior, increasing to 92.1% after training (Hosny et al., 2018; Matin et al., 2022). These findings indicate that educational interventions are very effective in changing behavior. Training increases awareness of knowledge and medical waste management behavior.

Providing training to dentists can reduce the amount of solid medical waste at the beginning of the year because it can provide information to increase dentists' knowledge so it can change dentist waste management behavior for the better. But this does not always last because the effect of the training will wear

off over time, resulting in the effect of forgetting. The good behavior started to deteriorate so the amount of waste produced was reduced (Abidah et al., 2021). Because the training effect is diminishing over time, it is recommended to provide training more than once. The obstacle to participating in training more than once is the cost, which is quite expensive because one training costs around 6 to 7 million rupiahs. To overcome this problem, it is recommended to conduct a joint intervention between providing training and cooperation with licensed waste management companies.

Based on the percentage in 13 amount of medical waste reduction over a period of 30 years, it was found that the combined scenario between providing training and cooperation with the waste management party had the largest percentage of waste reduction of 41.9%, followed by the cooperation scenario only of 29.5% and providing training scenario of 19.5%. The largest reduction in environmental costs was the combined scenario of 99.69% followed by the cooperation scenario of 99.62% and training of 19.5%. The percentage of medical waste reduction in each scenario can be seen in Figure 8.

In the first year, the largest percentage of waste reduction was found in scenarios 1 and 2 of 62.5%, and continued to decrease with increasing years. In scenarios 1 and 3, wherein the 10th year (2028) the percentage of waste reduction is predicted to be 44.3% for scenario 1 and 52% for scenario 3 (This can happen even though training can increase knowledge and change behavior, but this does not last long as time goes by within 10 years the effect of training has started to decrease by 18.2%. This may be caused by the provision of information by waste management training is only given once in 10 years so the effect of forgetting can occur (Manchanda et al., 2015; Bayusunuputro et al., 2021).

This circumstance suggests that increased knowledge can be sustained in the long term if there are good administrative and organizational rules that require adequate legislation and funding. Therefore, there must be ongoing training to ensure adequate knowledge and skills to manage medical waste properly (Bansal et al., 2013); (Wardani & Azizah, 2020).

Environmental costs can also be reduced by simulating a dynamic system model. The trend comparison results of environmental costs that must be incurred if intervention scenarios 1, 2, and 3 are conducted or not are shown in the following Figure 9.

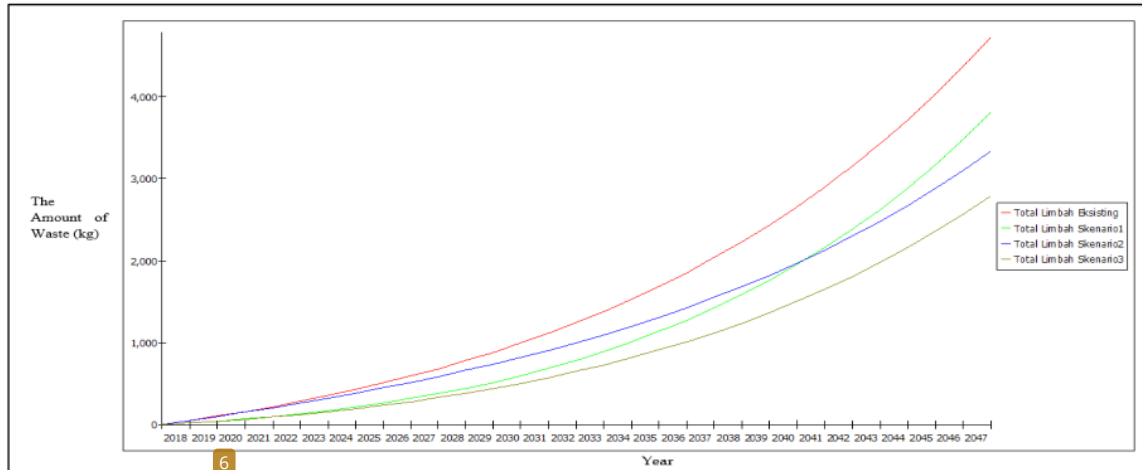

Figure 7. Comparison of the increase in the amount of solid medical waste for independent dental health services between the existing, training scenarios, cooperation with waste management scenarios, and combined scenarios of training and cooperation with waste management companies

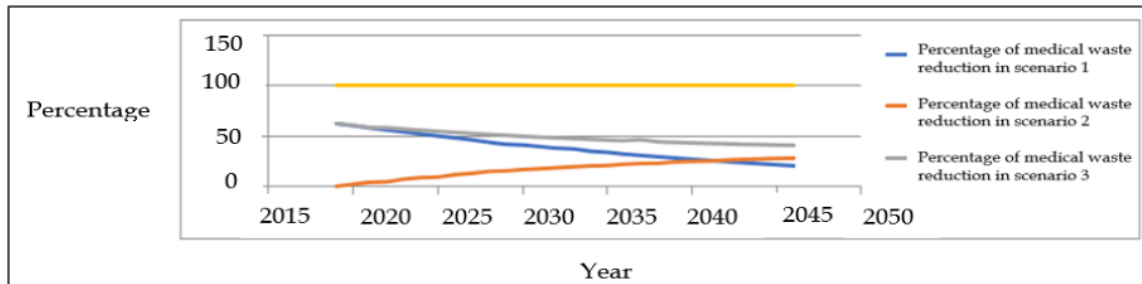

Figure 8. Trend comparison of solid medical waste reduction percentage for independent dental health services between the existing, training scenarios, cooperation with waste management scenarios, and combined scenarios of training and cooperation with waste management companies.

Table 2. Comparison of environmental costs in the existing state and three scenarios using dynamic system simulation modeling

Intervention	Environmental cost (Rupiah)				
	1 st year (2019)	5 th year (2023)	10 th year (2028)	20 th year (2038)	30 th year (2048)
Eksisting	14.603.490	85.148.593	206.183.891	550.495.508	1.404.526.724
Training (scenario 1)	5.756.680	33.514.543	111.455.791	378.086.118	942.268.687
Cooperation with waste transporters (Scenario 2)	78.672	420.820	936.112	2.282.813	5.340.299
Combined training cooperation with waste transporters (scenario 3)	29.504	193.257	524.124	1.639.560	4.472.303

Table 2 shows the comparative trend of solid medical waste management costs that must be incurred by the waste producer. In 2019, there was a decrease in costs between existing waste management, scenario 1, scenario 2, and scenario 3. Waste management by cooperation with waste management company intervention can reduce costs more than providing training scenarios. The most effective intervention of all is scenario 3, which is a combination of providing training and cooperation with a waste management company with a reduction percentage of 99.8% compared to costs without intervention, 94.7% compared to costs with training interventions, and 63% compared to cooperation interventions only. This is because there are no more environmental costs that must be incurred for the compensation of heavy metal pollution in the air and water. All solid medical waste made from heavy metals has been managed by a waste management company (Udofia et al., 2017; Bassey et al., 2006). Therefore, the dentist only needs to pay a private waste management service fee to the previous agreement of Rp. 40.000 per kilogram. This result is from a study by (Vaccari et al., 2018) which states that the total annual waste management costs are \$US 5.079.191, or around \$US 2.36 per kilogram. In Italy, the reduction of waste production and cost can be done in several ways, including increasing waste separation and linking the Italian national budget tax (TARI) with the cost of waste production.

Conclusion

The most effective model of independent health service solid medical waste management is scenario 3 model, which is a combined model of interventions to provide training in managing solid medical waste and operation with private waste management companies because it can reduce the amount of waste produced and reduce costs as well as reduce pollution, contracting diseases due to exposure to medical waste. Dentists and dental health officers need to take part in regular and continuous medical waste management training to change behavior.

References

- Abidah, H. N., Ismah, H. A., Irmayanti, S., Nurika, G., & Wikurendra, E. A. (2021). The Effectivity of Solid Medical Waste Management in Pandemic Era. *Journal of Public Health for Tropical and Coastal Region*, 4(3), 98-107. <https://doi.org/10.14710/jphtcr.v4i3.10618>
- Adipraja, P. F. E., Islamiyah, M., & Wahyuni, I. (2018). Utilization Management of Landfill Zones Based on Volume of Municipal Organic Waste Simulation. *IPTEK The Journal for Technology and Science*, 29(1). <https://doi.org/10.12962/j20882033.v29i1.3015>
- Al-Khatib, I. A., Eleyan, D., & Garfield, J. (2016). A system dynamics approach for hospital waste management in a city in a developing country: The case of Nablus, Palestine. *Environmental Monitoring and Assessment*, 188(9), 503. <https://doi.org/10.1007/s10661-016-5487-9>
- Artika, I., & Chaerul, M. (2020). Model Sistem Dinamik untuk Evaluasi Skenario Pengelolaan Sampah di Kota Depok. *Jurnal Wilayah dan Lingkungan*, 8(3), 261-279. <https://doi.org/10.14710/jwl.8.3.261-279>
- B. Lewis, J., S. Brady, S., Sutcliffe, S., L. Smith, A., R. Mueller, E., Rudser, K., D. Markland, A., Stapleton, A., Gahagan, S., Cunningham, S. D., & Prevention of Lower Urinary Tract Symptoms (PLUS) Research Consortium Prevention of Lower Urinary Tract Symptoms (PLUS) Research Consortium. (2020). Converging on Bladder Health through Design Thinking: From an Ecology of Influence to a Focused Set of Research Questions. *International Journal of Environmental Research and Public Health*, 17(12), 4340. <https://doi.org/10.3390/ijerph17124340>
- Bansal, M., Gupta, N., & Vashisth, S. (2013). Knowledge, awareness, and practices of dental care waste management among private dental practitioners in Tricity (Chandigarh, Panchkula, and Mohali). *Journal of International Society of Preventive and Community Dentistry*, 3(2), 72. <https://doi.org/10.4103/2231-0762.122436>
- Bassey, B. E., Benka-Coker, M. O., & Aluyi, H. S. A. (2006). *Characterization and management of solid medical wastes in the Federal capital territory, Abuja Nigeria*. 6(1), 5.
- Bayusunuputro, B. Z. N., Suryawati, C., & Nurjazuli, N. (2021). Solid Medical Waste Management Costs Between Outsourcing And Self-Managed System At Hospital During The Covid-19 Pandemic. *Jurnal Riset Kesehatan*, 10(2), 99-104. <https://doi.org/10.31983/jrk.v10i2.7031>
- Benakatti, D. V. B., & Kanathila, D. H. (2018). *Biomedical Waste Management In Dental Office - A Review*. 2(4), 6.
- Brady, S. S., Brubaker, L., Fok, C. S., Gahagan, S., Lewis, C. E., Lewis, J., Lowder, J. L., Nodora, J., Stapleton, A., Palmer, M. H., Prevention of Lower Urinary Tract Symptoms (PLUS) Research Consortium, Mueller, E., Fitzgerald, C. M., Hardacker, C. T., Hebert-Beirne, J., Lavender, M., Shoham, D. A., Burgio, K., Markland, A., ... Constantine, M. (2020). Development of Conceptual Models to Guide Public Health Research, Practice, and Policy: Synthesizing Traditional and Contemporary Paradigms. *Health Promotion Practice*, 21(4), 510-524. <https://doi.org/10.1177/1524839919890869>

- Chaerul, M., Tanaka, M., & Shekdar, A. V. (2008). A system dynamics approach for hospital waste management. *Waste Management*, 28(2), 442-449. <https://doi.org/10.1016/j.wasman.2007.01.007>
- Dewi, O., Ikhwan, Y., Nazriati, E., & Sukendi, S. (2019). The Characteristics and Factors Associated with Medical Waste Management Behaviour in Private Dental Health Services in Pekanbaru City, Indonesia. *Open Access Macedonian Journal of Medical Sciences*, 7(1), 157-161. <https://doi.org/10.3889/oamjms.2019.039>
- Eleyan, D., Al-Khatib, I. A., & Garfield, J. (2013). System dynamics model for hospital waste characterization and generation in developing countries. *Waste Management & Research: The Journal for a Sustainable Circular Economy*, 31(10), 986-995. <https://doi.org/10.1177/0734242X13490981>
- Hosny, G., Samir, S., & El-Sharkawy, R. (2018). An intervention significantly improves medical waste handling and management: A consequence of raising knowledge and practical skills of health care workers. *International Journal of Health Sciences*, 12(4), 56-66.
- Manchanda, K., Fotedar, S., Dahiya, P., Vats, A., Sarkar, A., & Vats, A. (2015). Knowledge, attitude, and practices about biomedical waste management among dental healthcare personnel in dental colleges in Himachal Pradesh: A cross-sectional study. *SRM Journal of Research in Dental Sciences*, 6(3), 166. <https://doi.org/10.4103/0976-433X.156215>
- Matin, H. H. A., Purwono, P., Alfajrin, A. C. A., & Inaku, A. H. R. (2022). Solid Medical Waste Management of Hazardous and Toxic at UNS Hospital Surakarta. *Jurnal Presipitasi: Media Komunikasi Dan Pengembangan Teknik Lingkungan*, 19(2), 398-407. <https://doi.org/10.14710/presipitasi.v19i2.398-407>
- Peraturan Menteri Kesehatan RI. (2019). *Peraturan Menteri Kesehatan Republik Indonesia Nomor 7 Tahun 2019 Tentang Kesehatan Lingkungan Rumah Sakit*.
- Peraturan Menteri Lingkungan Hidup dan Kehutanan RI. (2016). *Peraturan Menteri Lingkungan Hidup dan Kehutanan Republik Indonesia Nomor P.59/Menlhk/Setjen/Kum.1/7/2016 Tentang Baku Mutu Lindi Bagi Usaha dan/Atau Kegiatan Tempat Pemrosesan Akhir Sampah*.
- Retnowati, D., Fudhla, A. F., & Yani, A. (2021). Pemodelan Systems Dynamics pada Penanganan Sampah di Desa Penambangan Kabupaten Sidoarjo. *JURNAL TEKNIK INDUSTRI*, 11(3), 243-249. <https://doi.org/10.25105/jti.v11i3.13076>
- Shareefdeen, Z. M. (2012). Medical Waste Management and Control. *Journal of Environmental Protection*, 03(12), 1625-1628. <https://doi.org/10.4236/jep.2012.312179>
- Singh, H., Bhaskar, D., Dalai, D. R., Rehman, R., & Khan, M. (2014). *Dental Biomedical Waste Management*. 2(4), 3.
- Udofia, E. A., Gulis, G., & Fobil, J. (2017). Solid medical waste: A cross-sectional study of household disposal practices and reported harm in Southern Ghana. *BMC Public Health*, 17(1), 464. <https://doi.org/10.1186/s12889-017-4366-9>
- Vaccari, M., Tudor, T., & Perteghella, A. (2018). Costs associated with the management of waste from healthcare facilities: An analysis at national and site level. *Waste Management & Research: The Journal for a Sustainable Circular Economy*, 36(1), 39-47. <https://doi.org/10.1177/0734242X17739968>
- Wardani, R. A., & Azizah, R. (2020). Management of Solid Medical Waste on One of the Covid19 Referral Hospitals in Surabaya, East Java. *Jurnal Kesehatan Lingkungan*, 12(1si), 38. <https://doi.org/10.20473/jkl.v12i1si.2020.38-44>
- Wildanurizzal, Bahauddin, A., & Ferdinant, P. F. (2014). Perancangan Model Simulasi Pengelolaan Sampah Dengan Pendekatan Sistem Dinamis Di Kota Cilegon. *Jurnal Teknik Industri*, 2(3)
- Wulandari, P., & Kusnopranto, H. (2015). Medical Waste Management And Minimization Efforts At Public Hospital. Case Study: Public Hospital In East Jakarta, Indonesia. *Jurnal Kesehatan Masyarakat (Journal of Public Health)*, 9(2). <https://doi.org/10.12928/kesmas.v9i2.2127>

Simulation Design of Dental Practice Medical Waste Management Using Dynamic System Model Approach

ORIGINALITY REPORT

15%

SIMILARITY INDEX

12%

INTERNET SOURCES

3%

PUBLICATIONS

4%

STUDENT PAPERS

PRIMARY SOURCES

1	discovery.researcher.life Internet Source	7%
2	Submitted to Syiah Kuala University Student Paper	2%
3	Submitted to Universitas Indonesia Student Paper	1%
4	oamjms.eu Internet Source	1%
5	www.emerald.com Internet Source	1%
6	www.proceedings.lumenpublishing.com Internet Source	1%
7	link.springer.com Internet Source	1%
8	ijhs.org.sa Internet Source	<1%
9	www.semanticscholar.org Internet Source	<1%

Exclude quotes On

Exclude matches < 17 words

Exclude bibliography On